

SP 1200 S Deflection mirror

- 需要不止一个安全光幕/光栅
- 能实现四面的圆周保护
- 角度可使用2个随货带的支架来调整定位
- 特殊型号，如有需要，可在反射镜上配一个抗分割的保护膜
- 每个反射镜的光功率减少系数为15%
- 铝型材制作



Safety instructions

All the installation, connection and safety regulations, as per our technical information, have to be strictly adhered to.

The set-up of the products have to be made by skilled staff, only.

Repair exclusively made by di-soric.

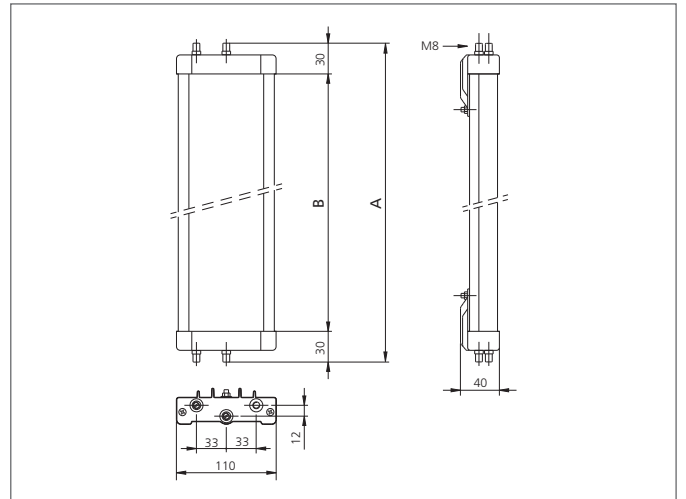

TECHNICAL INFORMATION (typ.)

总高度 (A)	1460 mm
操作原理	偏转镜
环境温度	-10 +55 ° C (反射镜)
为了	1210 mm protective field height
外壳材料	aluminium extrusion poles, epoxy powder coated, plastics
模型/型号	自由调节
交货范围	安装说明, 2个可调固定支架, Fixing material
光功率换算系数	15 %
偏转镜 (B)	1400 mm