

OGUP 020 G3-T3

High Performance Fork Light Barrier

- High transmission power and dirt penetration, factory setting "Power" sensor mode
- Dark-/light switching, push-pull
- High functional reserve
- Extremely dirt-resistant
- IO-Link
- 4 operating modes as IO-link parameter
- On-/off delay as IO-link parameter
- Diagnose via (by means of) IO-link
- Metal casing
- Integrated electronic module
- Sensitivity adjustable
- High operating frequency
- Bright ring LED
- High protection class

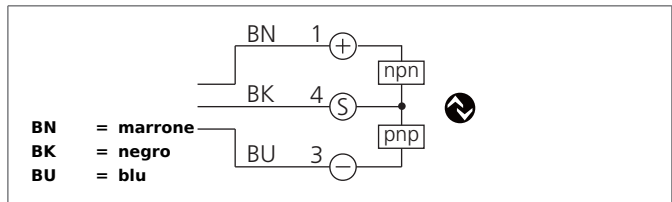
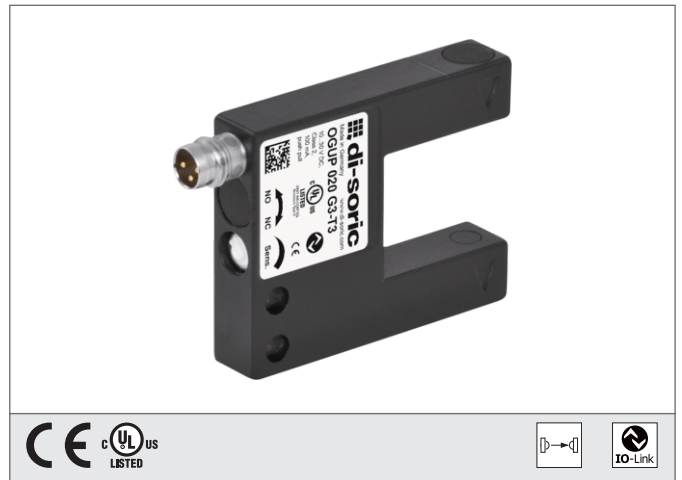

Safety instructions

The Instruments are not to be used for safety applications, in particular applications in which safety of persons depends on proper operation of the instruments.
 These instruments shall exclusively be used by qualified personnel.

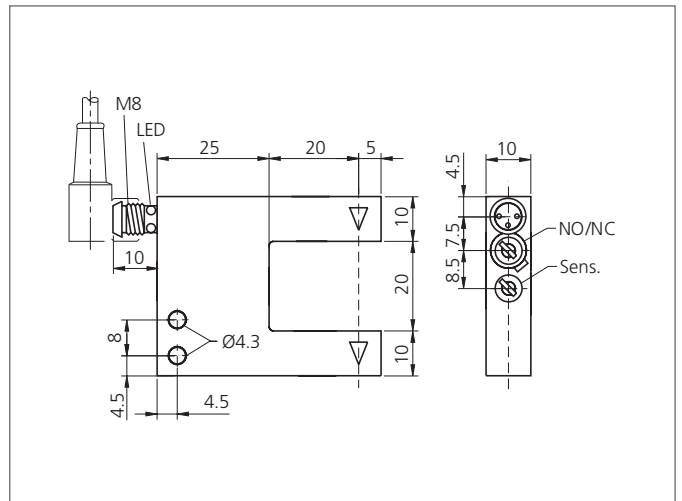

TECHNICAL INFORMATION (typ.)	+20°C, 24V DC
Operating principle	Optical
Evaluation	digital
Operating modes	Default, High resolution, Power, Speed
Size	40 x 50 x 10 mm (Dimensions)
Design	fork
Fork opening	20 mm
Branch length inside	25 mm
Characteristics	High transmit power and dirt penetration, Sensormode "Power"
Emitted light	Infrared, 860 nm, clocked
Service voltage	10 ... 30 V DC (Supply Class 2)
No-load current	< 30 mA
Resolution	Ø 2,0 mm (min. Ø 0,2 mm)
Sensitivity adjustment	potentiometer
Switching output	Push pull, 100 mA, NO/NC, switchable
Interface	IO-Link, V1.1, COM2 (38,4kBd), Smart Sensor Profile
Voltage drop	< 1,0 V
Switching frequency	200 Hz, (< 8000 Hz)
Reproducibility	0,03 mm (min. 0,02 mm)
Ambient temperature, operation	-25 ... +60 °C
Insulation voltage endurance	500 V
Protection class	IP 67
Protection degree	III, operation on protective low voltage
Casing material	Die-cast zinc black powder-coated

OGUP 020 G3-T3

High Performance Fork Light Barrier



TECHNICAL INFORMATION (typ.)	+20°C, 24V DC
Connection	Connector, M8, 3-poled
Connecting cable	TK ...
Mountable side by side	Yes