

US 18 M 800 IU-B4

Ultrasonic sensor

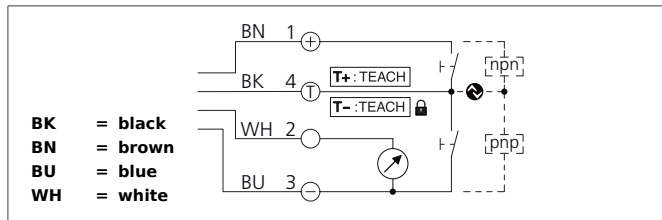

- IO-Link
- As a ultrasonic sensor or -barrier configurable
- Scanning range adjustable
- Analog output 4 ... 20 mA / 0 ... 10 V, depending on load
- Insensitive to dirt
- Insensitive to ambient noise
- Scanning does not depend on surface
- High frequency of measuring sequence
- High resolution



Safety instructions

The Instruments are not to be used for safety applications, in particular applications in which safety of persons depends on proper operation of the instruments.

These instruments shall exclusively be used by qualified personnel.

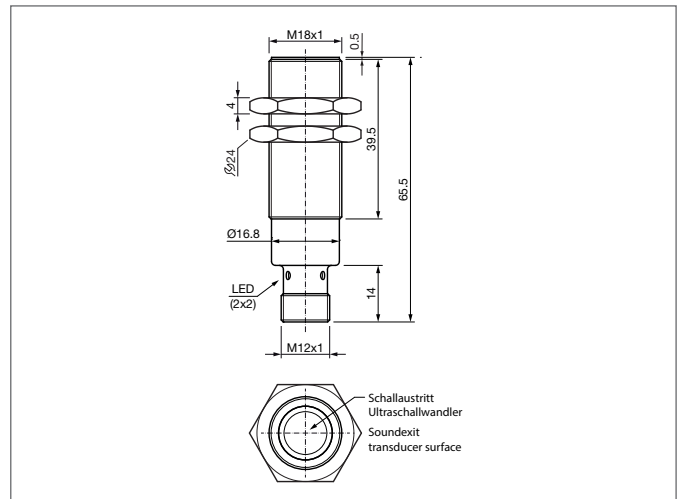

TECHNICAL INFORMATION (typ.)	+20°C, 24V DC
Operating principle	Ultrasonic sensor, Ultrasonic barrier
Evaluation	analog, digital (via IO-Link)
Size	M18 x 1 (thread)
Design	screw
Sending axis	axial
Characteristics	IO-Link
Nominal switching distance (Sn)	800 mm
Standardized measuring plate	20 x 20 mm
Service voltage	18 ... 30 V DC
No-load current	< 35 mA, (24 V DC)
Adjustment range	80 ... 800 mm, Teach in
Sensitivity adjustment	Remote teach
Switching output	Push pull, 150 mA
Switching hysteresis	4 mm, via IO-Link adjustable
Analog output	0 ... 10 V, 4 ... 20 mA
Interface	IO-Link, V1.1, COM2 (38,4kBd), Smart Sensor Profile
Display	LED: green - operation, yellow - output
Voltage drop	< 2,5 V
Switching frequency	> 5 Hz ... < 10 Hz
Readiness delay	< 300 ms
Ambient temperature, operation	-25 ... +70 °C
Temperature drift	0.2 %/K (uncompensated)
Load resistance	> 10 KΩ (0 ... 10 V) / < 400 Ω (4 ... 20 mA)

US 18 M 800 IU-B4 Ultrasonic sensor



TECHNICAL INFORMATION (typ.)	+20°C, 24V DC
Insulation voltage endurance	500 V
Protection class	IP 67
Protection degree	III, operation on protective low voltage
Casing material	brass nickel plated
Connection	Connector, M12 x 1, 4-poled
Scope of delivery	2 x M18 nuts