

OGU 080 VP3K-TSSL

Fork Light Barrier

- Light/dark switching
- Adjustable from the front
- Metal casing
- Integrated electronic module
- Sensitivity adjustable
- High operating frequency
- Bright ring LED
- High protection class
- 5-year warranty



Safety instructions

The Instruments are not to be used for safety applications, in particular applications in which safety of persons depends on proper operation of the instruments.

These instruments shall exclusively be used by qualified personnel.

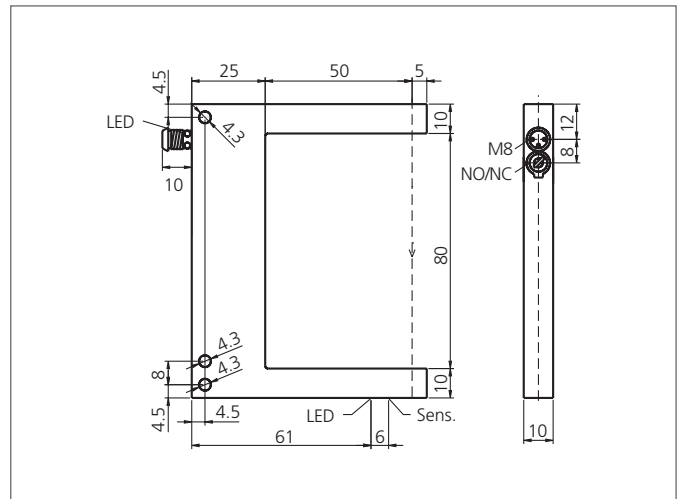

TECHNICAL INFORMATION (typ.)	+20°C, 24V DC
Operating principle	Optical
Evaluation	digital
Size	100 x 80 x 10 mm (Dimensions)
Design	fork
Fork opening	80 mm
Branch length inside	55 mm
Emitted light	Infrared, clocked
Service voltage	10 ... 35 V DC (Supply Class 2)
No-load current	< 30 mA
Resolution	Ø 0,5 mm
Sensitivity adjustment	potentiometer in front
Switching output	pnp, 200 mA, NO/NC, switchable
Switching hysteresis	< 0,25 mm
Shock-/vibration load	10 ... 55 Hz / 1,0 mm / 30 g
Voltage drop	< 2,8 V
Switching frequency	4000 Hz
Reproducibility	0,06 mm
Ambient temperature, operation	-10 ... +60 °C
Ambient light immunity	20 kLx
Insulation voltage endurance	500 V
Protection class	IP 67
Protection degree	III, operation on protective low voltage
Casing material	Die-cast zinc black lacquered finish

OGU 080 VP3K-TSSL

Fork Light Barrier



TECHNICAL INFORMATION (typ.)	+20°C, 24V DC
Connection	Connector, M8, 3-poled
Connecting cable	TK ...