

OGU 030 G3-T3

Fork Light Barrier

- Light/dark switching
- IO-Link
- 4 operating modes as IO-link parameter
- On-/off delay as IO-link parameter
- Diagnose via (by means of) IO-link
- Metal casing
- Integrated electronic module
- Sensitivity adjustable
- High operating frequency
- Bright ring LED
- High protection class
- 5-year warranty

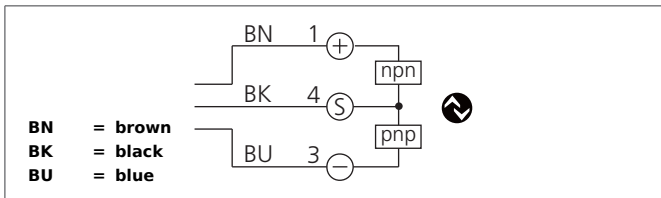

Safety instructions

The Instruments are not to be used for safety applications, in particular applications in which safety of persons depends on proper operation of the instruments.

These instruments shall exclusively be used by qualified personnel.

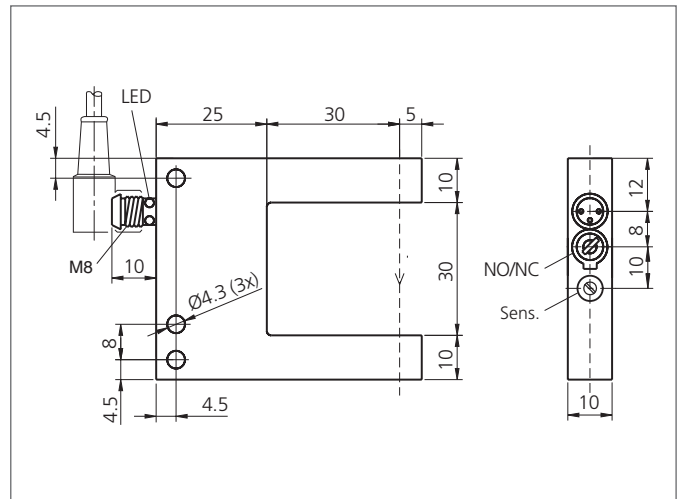

TECHNICAL INFORMATION (typ.)	+20°C, 24V DC
Operating principle	Optical
Evaluation	digital
Operating modes	Default, High resolution, Power, Speed
Size	50 x 60 x 10 mm (Dimensions)
Design	fork
Fork opening	30 mm
Branch length inside	35 mm
Emitted light	Infrared, clocked
Service voltage	10 ... 30 V DC (Supply Class 2)
No-load current	< 30 mA
Resolution	Ø 0,3 mm (min. Ø 0,2 mm)
Sensitivity adjustment	potentiometer
Switching output	Push pull, 100 mA, NO/NC, switchable
Interface	IO-Link, V1.1, COM2 (38,4kBd), Smart Sensor Profile
Switching frequency	5000 Hz, (< 8000 Hz)
Reproducibility	0,02 mm
Ambient temperature, operation	-25 ... +60 °C
Insulation voltage endurance	500 V
Protection class	IP 67
Protection degree	III, operation on protective low voltage
Casing material	Die-cast zinc black powder-coated
Connection	Connector, M8, 3-poled
Connecting cable	TK ...