

## SH-8-10 Sensor Holder Ø 8mm

- Highly flexible versatile mounting system
- All-purpose mounting
- Smooth adjustment
- Robust design

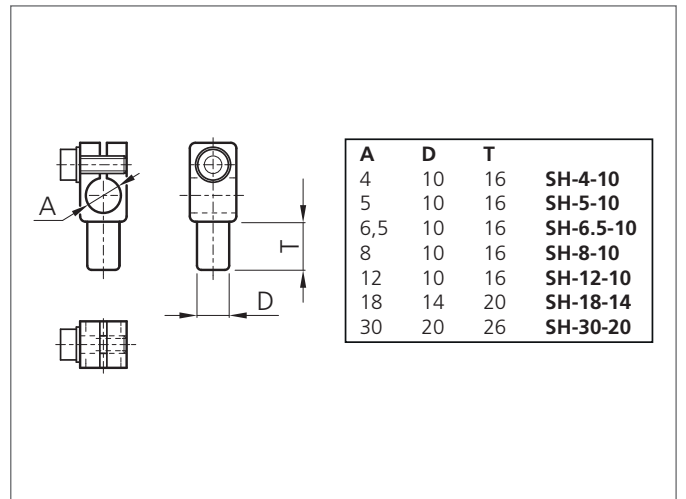
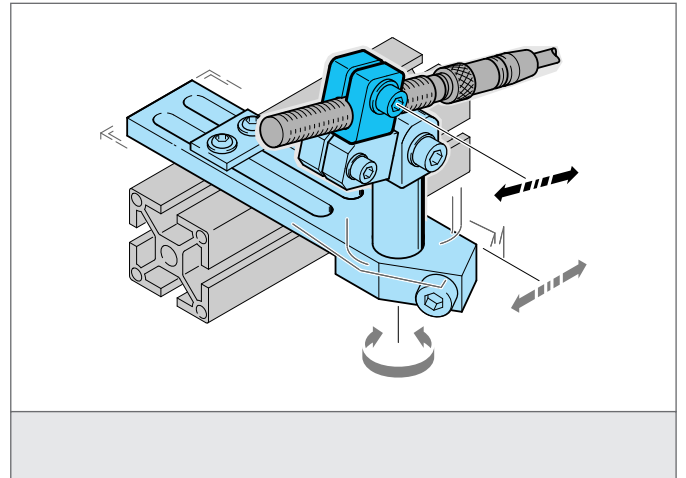

### TECHNICAL INFORMATION (typ.)

Size	<b>+20°C, 24V DC</b> 8,0 mm (Diameter A) 10 mm (Spacer measure D)
Suitable for	Clamping pin 10 mm
Casing material	polyamide
Product series	System holder HS