

M8K/M12S/4 Adapter Connector

- Spojka M8, 4-pólový / konektor M12, 4-pólový
- Kovový závit otočný
- Vysoký stupeň krytí až IP 67

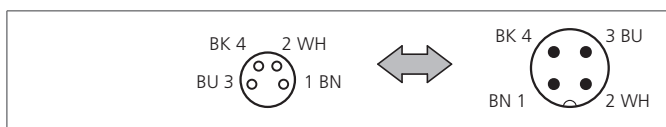

CE



Safety instructions

The Instruments are not to be used for safety applications, in particular applications in which safety of persons depends on proper operation of the instruments.
These instruments shall exclusively be used by qualified personnel.

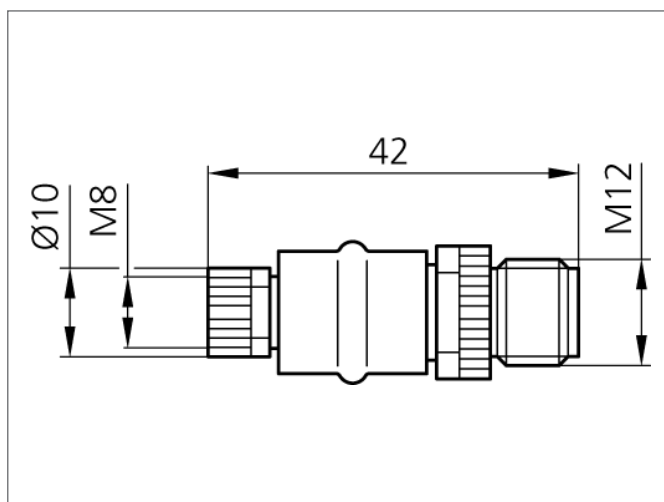

TECHNICAL INFORMATION (typ.)

Tvar	P ímý
Provozní nap í tí	< 24 V P i max. 4.0 A
Stupeň krytí	IP 67
Materiál pouzdra	Plast
Connection sensor side	Zásuvka, M8x1, 4-pólový
Connection control side	Konektor, M12x1, 4-pólový