

Standard enclosure
Series CT (ABS)

Designation CT-582 ABS

Article number 358000000

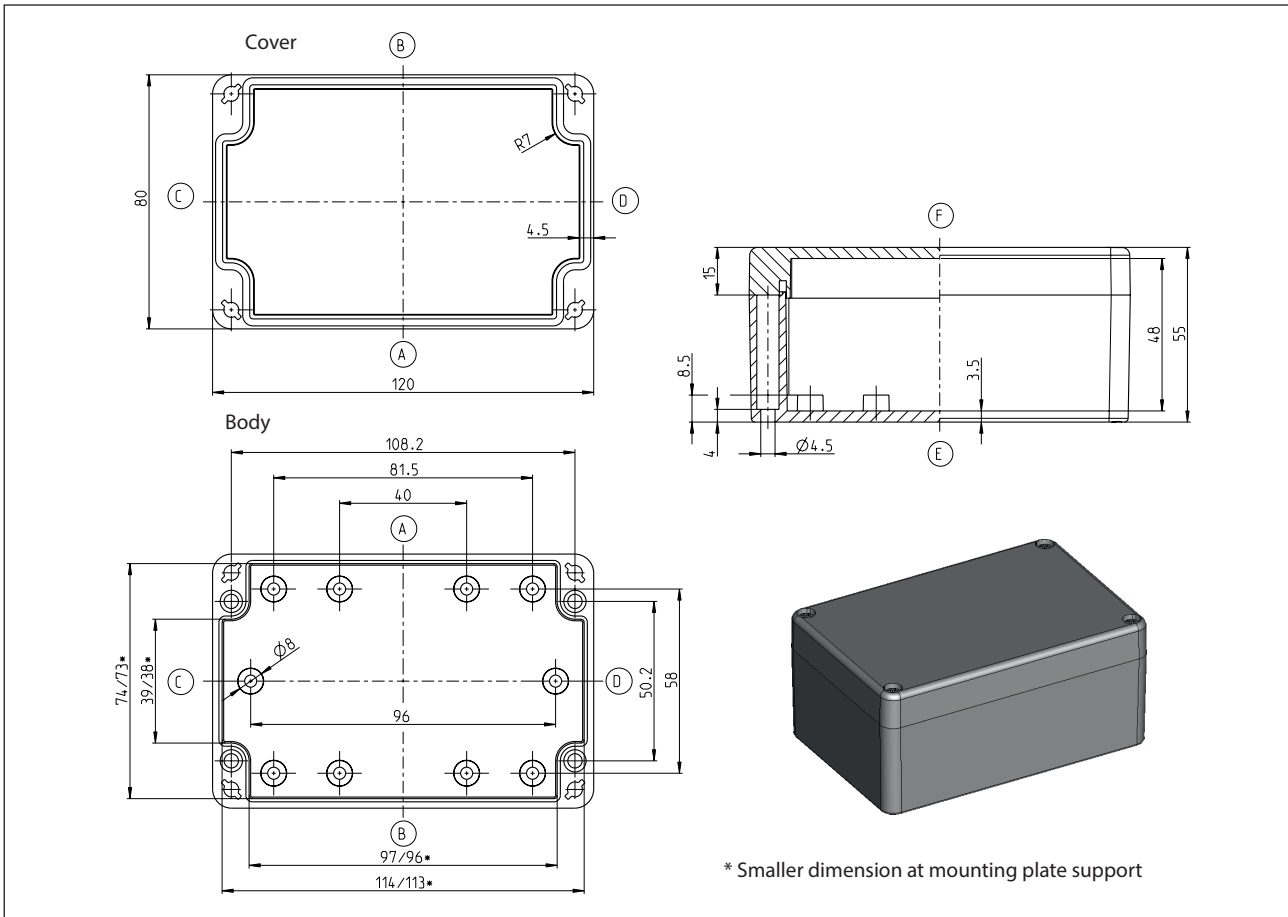

Standard version

Scope of supply:

Base of enclosure

Enclosure cover

Quick-release screw (cross recessed head) enclosed loosely

Colour RAL 7035 (light grey)

Cover gasket PUR (polyurethane)

Internal mounting plugs for selftapping screws (are included)

Individually packaged in foil

Maximum possible number of thread (figures for identical diameter, not mixed!)

ISO M	M12	M16	M20	M25	M32	M40	M50	M63
Page A/B	9	4	3	2	0	0	0	0
Page C/D	2	1	1	0	0	0	0	0

Property chart CT-582

Specification	Value	According to the standard	Remark
General data:			
Weight	135 g		
External dimensions	120 x 80 x 55		
Protection classes			
IP code	IP 66	EN 60529	
IK code	IK 07	IEC 62262	
Material			
Enclosure	ABS		light grey
Quick-release fastener	1.4303		DIN EN 10088-3
Cross-recessed pan head tapping screws	ST		galvanised
Seal	PUR (Polyurethan)		Colour: dark grey, 2-component polyurethane foam seal
Toxic behaviour	halogen-free		
Thermal properties:			
Fire behaviour			
Flammability	HB	UL 94	Contentwise alike with EC60695-11-10 and IEC60695-11-20
Flame class:	1,2 mm HB 75	IEC 60695-11-10	
Flame class:	1,5 mm HB 75	IEC 60695-11-10	
Flame class:	3 mm HB 40	IEC 60695-11-10	
Temperature range			
Enclosure complete	-40 °C bis +100 °C		
Enclosure material	-40 °C bis +120 °C		
Seal PUR	-40 °C bis +100 °C		
Temperature index Enclosure material			
RTI (tensile strength)	60 °C	UL 746 B	
RTI (impact strength)	60 °C	UL 746 B	
RTI (dielectric strength)	60 °C	UL 746 B	
Ambient temperatur according to DIN EN 62208			
Indoor application	-5 °C bis +40 °C	DIN EN 62208	On the average over 24h +35°C
Relative humidity according to DIN EN 62208			
Indoor application	max. 50% bei +40 °C	DIN EN 62208	with low temperatures also higher (for ex. 90% at +20°C)
Storage temperature	-20 °C bis +60 °C		
Enclosure-specific thermal conductivity value	6,21 K/W		taking account of effective dissipation loss

Property chart CT-582			
Specification	Value	According to the standard	Remark
Mechanical properties:			
Torques			
quick – release screw	1/4 Rotation		
Attachment of accessories	1,0 Nm		for ex. mounting plates, mounting rails
Other mounting	1,0 Nm		Screw channel, External mounting brackets
Maximum installation weight	0,3 kg		
Electrical characteristics:			
Protection class	II	EN 61140 / VDE 0140-1	 Protection by double or reinforced insulation
Rated voltage	max. 1000V		Maximum length of the extension arm
Surface resistivity	10 ¹³ Ohm	IEC 60093	
Dielectric strength	23 kV/mm	IEC 60243-1	short-term
More details:			
General tolerance	mH	ISO 2768	
Product standard	Yes	DIN EN 62208	Empty enclosures for low-voltage switchgear assemblies
Approvals			
c UL us	No		
Compliances			
RoHs	Yes	Directive 2011/65/EU	
CE label	Yes	EC-No 765/2008	
Low-Voltage-Directive No.:	2014/35/EU		