

Safety switch Series SRF

Description **SRF-0-R18**

Article number **6075687144**

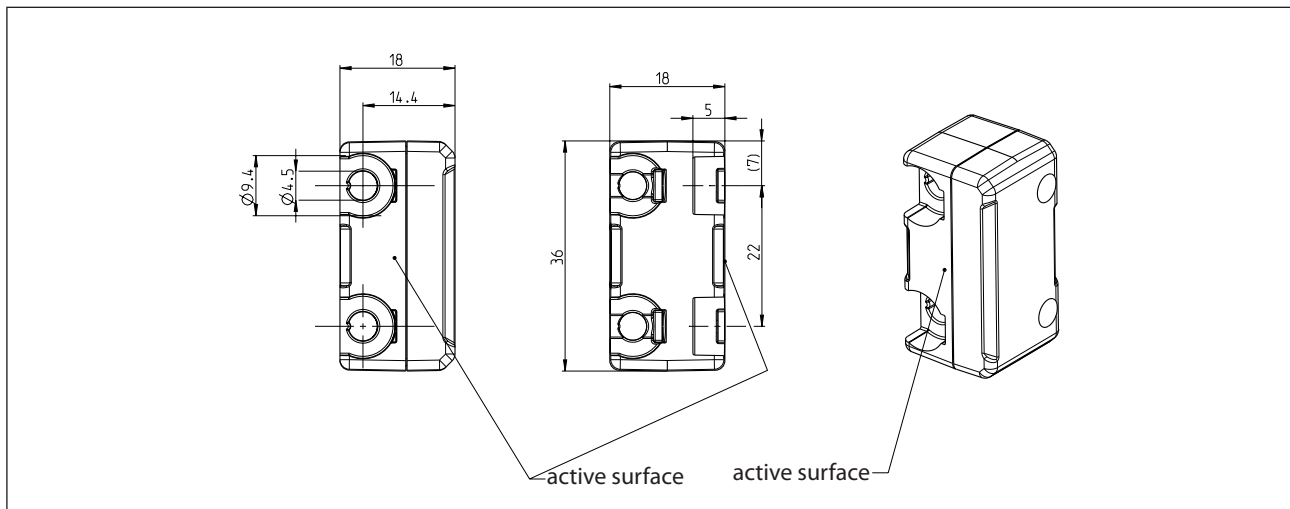

Sensing distance (Only in conjunction with SRF of the BERNSTEIN AG.)

		min.	typ.	max.
Rated sensing distance	S_n		13 mm	
Assured sensing distance – On	S_{so}	10 mm		
Hysteresis	H		2 mm	
Assured sensing distance – Off	S_{ar}			25 mm

Electrical Data

Transponder frequency		125 kHz
Repeatability	R	$0,1 \times S_n$

Mechanical Data

Enclosure	PA 66 + PA6, red
Mounting	2 holes $\varnothing 4,5$ (for M4 screws)
Shock and Swing	acc. to EN IEC 60947-5-2
Ambient temperature	-25°C ... +70°C
Storage temperature	-25°C ... +70°C
Maximum relative humidity	93 % @ 40 °C without condensation
Altitude	≤ 2000 m NHN
Type of protection	IP69

Approvals Only in conjunction with SRF of the BERNSTEIN AG

TÜV Nord, cCSAus